

Two Approaches for Tangible Navigation in Virtual Environments

Vladimir Yelistratov
yelistratov@gmd.de

Wolfgang Strauss
strauss@gmd.de

Monika Fleischmann
fleischmann@gmd.de

GMD - German National Research Center for Information Technology
Sankt Augustin, Germany

Abstract

This paper presents two approaches for development of intuitive physical interfaces for tangible navigation in virtual environments. The first discussed interface called “Virtual Balance” borrows the ideas from well-known and immediately understandable to everyone principles of steering of a snowboard down a mountain. This interface is realized as a platform that reacts on the body movements of the user which is staying on it. The position of the user in the virtual environment is updated in accordance with the data from that platform.

The second interface uses electrostatic field sensors for gestural navigation in virtual environments.

Both approaches do not require wearing or keeping uncomfortable equipment.

Keywords: *human-computer communication, virtual reality, intuitive interfaces, body balance, electrostatic field sensors.*

1 Introduction

In order to examine the meaning within the framework of mediated reality, we need interfaces which allow the user a high degree of natural freedom of movement. For this reason, research in recent years has been increasingly devoted to the development of human-computer interfaces which avoid the use of limiting apparatuses and attempt to most effectively allow a complete freedom of movement of the body.

Virtual Environments still suffer from input and output devices that work against the human body and mind. The body with its communication channels (skin, eyes, ears, voice) opens imagination spaces. Body motion is fundamental to learning and living. Interaction and feedback intensify capabilities of perception.

The authors’ main interest is to develop systems that focus on the linking of real and virtual environments and the users sense of presence. This aim is also reflected in earlier works: *The Spatial Navigator* [2] uses a treadmill where the viewer walks through a virtual castle. *The Responsive Workbench* [3] has put the conventional dialogue concepts for human-computer communication into a user-oriented shape. Virtual objects and tools are projected stereoscopically on a

real workbench as a virtual design environment. The computer art installations *Rigid Waves* [4], a mirror based on image processing and *Liquid Views* [4], a water surface based on a touch screen stride new ways in human-computer communication, where the interface is tangible to support the users perceptual process.

This paper presents two approaches for development of intuitive physical interfaces for tangible navigation in virtual environments.

We describe our recent improvements and investigations of the interface Virtual Balance (VB) [5]. This interface is realized as a platform that reacts on the body movements of the user which is staying on it. The position of the user in the virtual environment is updated in accordance with the data from that platform.

The second interface uses electrostatic field sensors for gestural navigation in virtual environments. The free user’s hand moving in the vicinity of antennas affects the parameters of the complex electrical circuit that includes those antennas and the hand grounded through the user’s body. The changes of those parameters are mapped to the parameters of the user’s viewpoint in the virtual environment.

For each interface we discuss physical principles, underlying ideas, actual implementation and operation of the interfaces and mapping of data.

2 Navigation with the Virtual Balance

2.1 Physical principles, underlying ideas

The interface VB is based on man-machine interaction by movements of the human body on a platform. The platform consists of two circular plates (disks) with three weight sensors arranged in triangular form between these disks. The sensors receive changes of weight distribution on the upper disc and transmit them to an analysis unit which in turn controls the position and orientation of the user’s viewpoint in the virtual environment. The number of the sensors and their location are derived from the well-known fact that any plane is stabilized by three force vectors F_1 , F_2 , F_3 against a contradictional force vector F_g (i.e. the weight of the object). It is quite obvious that the point on the upper disk to which user’s weight is applied at the given moment can be unam-

biguously calculated from three numbers from the sensors, as it is shown on the Figure 1.

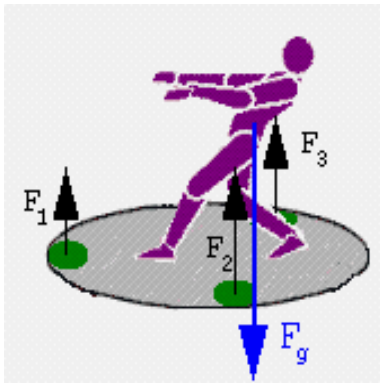

Fig.1. The physical principles of the VB.

2.2 Implementation

We use a personal computer as an intermediate stage between input signal measurement (weight sensors) and SGI's graphics workstation. The signal from the weight sensors are sampled via three I/O ports. From these separate signals the barycenter coordinates of the user's body on the platform (the location of the point on the disk to which the user's weight is applied) are calculated and sent to the SGI's graphics workstation over a fourth I/O channel for rendering of the new scene. The data sent from the PC to the graphics workstation as input for scene rendering consist of two coordinates for the barycenter on the navigation platform and total weight measured by three sensors. From these data the current position, speed and orientation of the user's viewpoint are calculated in accordance with the chosen mode of navigation.

2.3 Mapping of data from the VB

To navigate through large architectural models like the models of ancient cities (see Applications) the user must be provided with the opportunity to change the position of the viewpoint in the 3D space, to change its orientation on the horizontal plane, to move with different speed to see more or less details of the virtual environment. At the same time when choosing the appropriate mapping one should consider the following facts:

- 1) The VB provides only two independent streams of data (coordinates on the disk's plane)
- 2) Untrained user must not undertake special complex actions to change the parameters of the motion in the virtual environment.

In our current implementation the data from the VB are mapped in the way described below and depicted on the Figure 2.

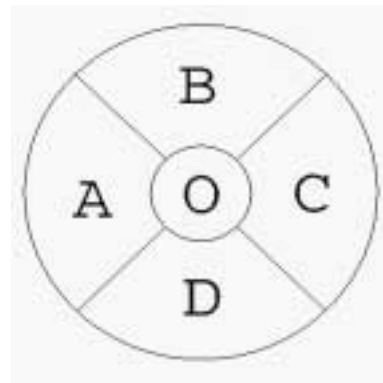

Fig.2. Mapping of data from the VB.

For the simplicity we will call the position of the point on the VB's upper disk to which the user's weight is applied 'the position of user's weight'.

If the user's weight is applied to the central area O no parameters of the user's viewpoint are changed. This is neutral area.

When the user's weight is applied to the area A or C correspondingly to the left and to the right from the central area the user's viewpoint turns in the virtual environment with angular velocity increasing linearly with the distance from the position of the user's weight on the disk to the center of the disk. So with the given speed of the motion in the virtual environment the user's weight has to be closer to the left or to the right border of the VB's disk to fit to a turn with smaller radius in accordance with the well-known formula from mechanics $\vec{v} = [\vec{\omega}, \vec{r}]$.

In addition the user's viewpoint rotates around the vector of the speed in the virtual environment on an angle increasing linearly with the distance from the user's weight to the center of VB's disk.

These functionalities provide more immersion for the motion in the large architectural models and simulates well known mechanical effect which motobikers and skiers experience when trying to fit on the high speed to a turn with rather small radius. They have to lean very close to the ground to displace the center of gravity closer to the center of the turning. This action decreases the force of friction from the ground and prevents the person from the breakdown.

Figure 3 illustrates these principles.



Fig.3. Making a turn with the VB. The top view of the model of Aztec city is shown on the left top corner.

When the user's weight is located in the area B or D (Figure 2) before or behind the central area of the disk the user changes the height of his viewpoint in the virtual environment: decreasing (area B) or increasing it (area D). In addition, the orientation of the user's viewpoint turns around the axis parallel to the horizontal plane and perpendicular to the vector of the speed of the motion in the virtual environment. The angle of the turning is increased linearly with the distance from the user's weight to the center of the disk. This feature simulates the following effect. When the user is on the back side of the disk, the forward part of the virtual platform on which the user flies in the virtual environment is going up, and the height is being increased. In the same manner when the user is on the forward part of the VB's disk the forward part of the virtual platform is going down and the height is being decreased.

The data provided by the VB are not enough to change the speed of motion in the virtual environment in the same intuitive manner. We propose two solutions to this problem.

1) The speed depends on the height of the user's viewpoint in the virtual environment. In the large architectural models all information is located on the ground. So it makes sense to move with relatively small speed on the ground to see the model in details and to fly with a larger speed in some height from the ground where the opportunity to see more details is not important.

2) The change of the mode of the mapping of data from the VB through some predefined actions of the user on the VB's platform. One can use the areas B and D on the disk not only for increasing and decreasing the height of the user's viewpoint in the virtual environment but also for increasing or decreasing the speed of motion. We implemented the following way of the change of the mode of the mapping of data from the VB. If the user wants to increase the speed of motion he goes back on the platform (so his weight is located in the area D) and immediately goes forward (his weight now is located in the area B). The time between these two events must not be greater than 1 second or another small predefined value, otherwise the change of the mode does not occur (Figure 4).



Fig.4. The change of mode of the VB through predefined actions of the user on the VB's platform.

Until the user's weight is located in the area B the speed of the motion in the virtual environment is being increased depending on the distance from the user's weight on the VB's platform to the center of the disk. Once the user's weight leaves the area B, the mode of the mapping of data returns to its usual state when areas B and D are used for changing the height. In the same manner the user can decrease the speed of the motion in the virtual environment.

However testing of this feature with different people showed that such actions can not be considered as intuitive and some time is required for adaptation to this functionality.

We use the first mentioned method of changing of the speed of motion in the virtual environment in our public demonstrations when our visitors navigate through large architectural models (see the next section).

2.4 Applications

Our numerous tests with different users show that the interface VB is well suited for investigation of large architectural models, like reconstructed models of ancient cities. We use the model of the Roman village Colonia Ulpia Traiana (100 a.o.t) created from archaeological data by joint work of architects, civil engineers, archaeologists and computer scientists. Body navigation determines height and speed. Depending on the navigator's distance from the virtual objects, different levels of detail (LOD) are activated. To help the user to navigate through a large model that is spread over a rather large area we introduced the top view with a cursor showing the current user's position in the virtual environment as well as the current orientation of the user's viewpoint (Figure 3). We use as the top view the 2D image created beforehand to save computational resources. Depending on the available computational resources one can use in our framework a virtual mirror to give the user a notion of the entire environment surrounding him. However one should use the virtual mirror with care since the use of it assumes recalculation of all normals of the virtual environment, resulting in a very small frame rate.

3 Gestural navigation with electrostatic field sensors

3.1 Underlying ideas

The operation of this interface is based on the same underlying principles used in the musical instrument called Theremin and invented by Russian scientist Lev Termen (Leon Theremin) in the early 1920's. Figure 9 at the end of this paper shows the design of a classic Theremin.

The main parts of the device are two LC oscillators with very close own frequencies. One of them has fixed capacitance and inductance, the second has an external antenna connected to its capacitor. By moving a hand into the vicinity of the antenna the user actually adds the capacitance C_{h1} to the oscillator. Since the user's hand is grounded through his/her body the capacitor C_{h1} is connected in parallel with the capacitor C_0 . As the user varies the distance of his/her hand from the antenna, the capacitive coupling and the resulting frequency ω_1 is changed according to the formula $\frac{1}{\sqrt{L_0(C_0+C_{h1})}}$. Because the capacitance C_0 is usually very small (typically below a picofarad), this oscillator must be run well above audio frequencies (typically 100 kHz to 1MHz) to attain significant coupling and dynamic range. The radiofrequency wavelength is approximately 3 km at 100 kHz, therefore most Theremins and devices based on their principles of operation should be analyzed as a slowly varying electrostatics problem with negligible radiation effects. The hand dependent frequency ω_1 is then down-shifted to audio band by mixing the ω_1 signal with a fixed frequency reference ω_0 and detecting the new frequency beats at $\omega_0 - \omega_1$. Theremins usually use a second proximity-variable oscillator/antenna ω_2 to control the amplitude of the audio signal. The ω_2 signal is applied to a steep bandpass filter, than the amplitude of its output is detected to determine the gain of a voltage controlled amplifier (VCA) in the audio path. As a hand moves near this volume-controlled antenna, ω_2 moves into tune with the band pass filter, changing the audio level through the VCA. So one can play music controlling the pitch and the volume of the sound simply moving the hands near the pitch and volume antennas and not touching anything.

The general idea of the Theremin, affecting the parameters of the oscillator via user's body motion, can be used in a variety of applications for proximity sensing. In such applications a set of antennas is used to provide more data about space characteristics of matter induced the change of oscillator's characteristics.

The system developed in MIT Media laboratory and used for different modes of navigation in the 3D world is described shortly below. More details are given in [6, 7, 8].

3.2 Related work

In the framework developed by Physics and Media Group of MIT there are distinct transmit and receive electrodes. As a hand approaches the area of sensitivity of the electrodes the current on each electrode decreases since a part of it goes through the hand to the ground. The specially built hardware board is used for measurement with the help of special signal processing technique the current I_i and the voltage V_i on each electrode i and determining so called capacitance matrix coefficients C_{ij} [9] from the formula

$$I_i = \frac{dQ_i}{dt} = \frac{d}{dt} \sum_j C_{ij} V_j = \sum_j C_{ij} \frac{dV_j}{dt}, \quad (1)$$

where $Q_i = \sum_j C_{ij} V_j$ is the total charge on electrode i induced by all the other electrodes.

Then, the nonlinear inverse problem is solved to extract hand's parameters from the quantities C_{ij} .

In the MIT's approach for electrostatic field sensing it is possible to make $\frac{n(n-1)}{2}$ distinct measurements using only n electrodes, when each electrode is used both as a transmitter and a receiver.

To determine the hand's orientation the hand is represented as a set of conducting spheres as it is done in the computer graphics concept of "metaballs" in which any part of a human body is represented as a set of spheres.

3.3 Setup: electrostatic field sensors desktop interface

In our present implementation we use two specially designed Theremins with long cylindrical antennas connected to each Theremin (Figure 5).



Fig.5. Setup of the system of Theremins for navigation in virtual environments.

These Theremins were designed by Martin Nawsrath at KHM-Academy of Media Arts (Köln). In this device the output can be provided in two forms: usual audio output and

digital output that gives the values of the shift of the base frequency of the audio signal from its “neutral” value at each time of sampling. The basic frequency of the Theremin’s oscillator when the user’s hand is out of the area of the Theremin’s antenna sensivity is assumed under the ‘neutral’ value. The digital output of each device is connected for processing to the serial input of the computer. When this installation is used for navigation in virtual environments the position of user’s viewpoint is updated in accordance with the data coming to the serial inputs of the computer from the Theremins (Figure 5).

The digital output in each Theremin is supplied by microprocessor which performs the Fourier transform of the audio signal. It also sets the pitch to zero when the pitch does not change during the predefined time (10 s in our application). The actual frequency of the Theremin’s oscillator corresponding to that newly set pitch becomes the neutral value for which the shift is calculated. One can say the microprocessor performs the calibration of Theremins’ output setting it to zero when there is no change of antenna’s environment for a relatively long time.

Before describing the actual operation of our system and mapping of data from the Theremins to parameters of the user’s viewpoint in the virtual environment we introduce the physical principles of our implementation.

3.4 Physical principles of our implementation

When the user’s hand is in the area of sensivity of the antennas the equivalent electric scheme presented on the Figure 10 at the end of this article can be used for describing the physical properties of our application. The capacitances C_{h1} and C_{h2} between the hand and each of antennas and the capacitance C_A between the antennas depend on the current position of the hand. The capacitance C_h is dominated by the capacitance between the surface of the shoes of the user and the ambient room ground. It is typically much larger than capacitances C_{h1} and C_{h2} . Capacitances C_{h1} , C_{h2} and C_A are always much less than C_1 or C_2 . One can show using those assumptions that oscillations with two frequencies are presented in the electrical circuit of the Figure 10:

$$\omega_1 = \frac{1}{L_1 C_1} \left(1 - \frac{C_A}{2C_1} - \frac{C_{h1}}{2C_1}\right) \quad (2)$$

$$\omega_2 = \frac{1}{L_2 C_2} \left(1 - \frac{C_A}{2C_2} - \frac{C_{h2}}{2C_2}\right) \quad (3)$$

Note, that native frequencies $\frac{1}{L_1 C_1}$ and $\frac{1}{L_2 C_2}$ of each Theremin must differ much enough for the microprocessor to follow their shift when the environment near antennas is being changed. Otherwise the microprocessor might mix the frequencies and follow the shift of the second frequency. On that reason we use Theremins in which native frequencies (655 kHz for the first Theremin and 455 kHz for the second one) differ on a significant value.

Neglecting the change of C_A when the hand is moving in the vicinity of antennas and denoting $\frac{1}{L_i C_i} \left(1 - \frac{C_A}{C_i}\right)$ as ω_{i0} , $i = 1, 2$ we can rewrite the expression for ω_i as

$$\omega_i = \omega_{i0} - a_i C_{hi}, \quad (4)$$

where $i = 1, 2$, $\omega_{i0} = const$, $a_i = const$

Thus, the shift $\tilde{\omega}_i$ of the basic frequency from its neutral value is proportional to C_{hi} for each Theremin i .

One can show [9] that for the system of two long thin conducting cylinders and a grounded sphere which simulates the user’s hand, C_{hi} can be presented in the form

$$C_{hi} = \frac{A_i}{r_i^2} \quad (5)$$

for each Theremin i . Here r_i is the distance from the hand to the axis of the cylinder i , A_i is the coefficient which does not depend on the distance r_i and depends only on the angle φ_i as shown on the Figure 6.

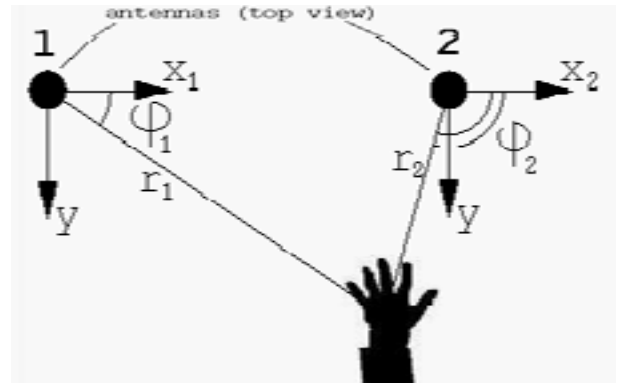

Fig.6. Designations in (5).

The infinitesimal change of the quantities $\tilde{\omega}_i$, $i = 1, 2$ is

$$\tilde{\omega}_i = \frac{2A_i}{r_i^3} \Delta r_i - \frac{dA_i}{r_i^2} \Delta \varphi_i \quad (6)$$

Substitution of Δr with $\Delta r = \frac{\Delta x x + \Delta y y}{r}$ and neglecting the second term in (6) as the A_i changes with the change of angle φ_i very slowly gives:

$$\tilde{\omega}_i = \frac{2A_i}{r_i^3} \frac{\Delta x_i x_i + \Delta y y}{r_i} = \frac{-2\tilde{\omega}_i}{r_i^2} (\Delta x_i x_i + \Delta y y) \quad (7)$$

We have such equation for each Theremin. Reverting of the resulting system of equations we obtain the following equations for the change of the position of the user’s hand:

$$\Delta x = \frac{-r_2^2 \frac{\Delta \tilde{\omega}_2}{\omega_2} + r_1^2 \frac{\Delta \tilde{\omega}_1}{\omega_1}}{2(x_1 - x_2)} \quad (8)$$

$$\Delta y = \frac{-\frac{x_1}{y} r_2^2 \frac{\Delta \tilde{\omega}_2}{\omega_2} + \frac{x_2}{y} r_1^2 \frac{\Delta \tilde{\omega}_1}{\omega_1}}{2(x_2 - x_1)} \quad (9)$$

Note that the difference in the denominator of each equation is just a distance between the antennas.

Understanding the physical principals of our implementation we are now describing the actual operation of the system.

3.5 Operation of the system

Equations (8,9) show that to calculate the displacement of the hand in the area of the antennas' sensitivity one must know the previous positions of the hand.

In our application the distance between the antennas can be variable. On that reason we use that distance as a unit in the system of reference depicted on the Figure 7.

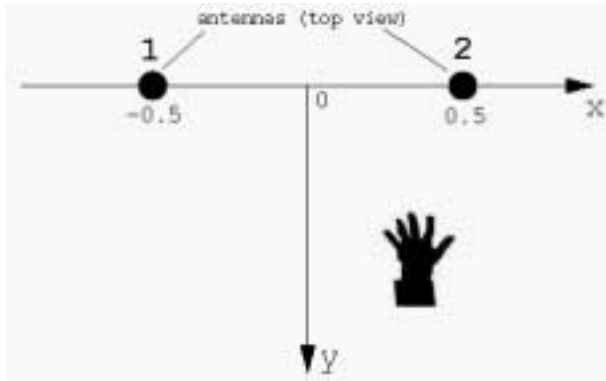

Fig.7. The system of reference in our application.

It is quite obvious that only points $(-0.5, 0)$ or $(0.5, 0)$ where the centers of antennas are located can be used as initial locations of the user's hand. The location of hand's surface in this area can be detected by extremely large shift of the frequency in the corresponding Theremin.

Once the initial location of the hand is known the equations (8,9) can be used for building the table $x, y, \tilde{\omega}$ for each Theremin, where the shift of the frequency $\tilde{\omega}$ corresponds to some position x, y of the hand.

Such procedure can be used for calibration of the system when the environment of the system has been changed (e.g. the distance between the antennas has been changed, the system has been placed to another place, etc). For making that calibration the user is just required to touch one of the antennas and move his/her hand in the vicinity of the antennas slowly observing the representation of the hand on the monitor. After successful calibration recorded data are used for producing interpolation over the predefined grid. After this step our system can be used for usual operation which is briefly described below.

At each moment the Theremin i provides as output the shift of the frequency $\tilde{\omega}_i$ from the neutral value. For this value the isoline is calculated from the interpolated calibration data. The position of the hand is determined as an intersection of the isolines from two Theremins.

There is no need for very precise measurements of the position of the user's hand; nevertheless such procedure gives quite acceptable results.

3.6 Mapping of data and applications

We implemented two commonly used modes of navigation: the "examine" and "walk" modes.

In the "walk" mode the y coordinate serves for determining the speed of the motion in the virtual environment. The speed depends linearly on the y and is maximal if $y = 0$.

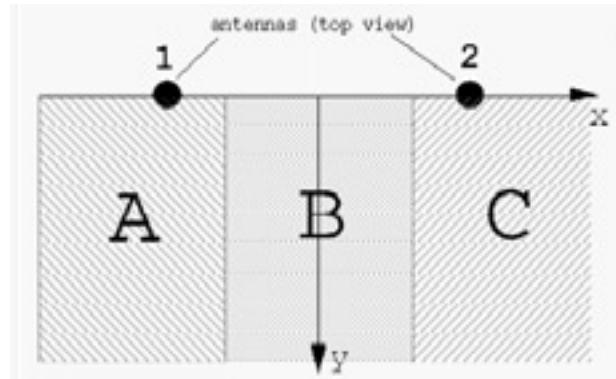

Fig.8. Mapping of data from the Theremins.

If the user's hand is located in the area A or C (Figure 8) the user's viewpoint begins to turn with an angular velocity increasing linearly with the distance from the current hand's location to the border with the area B. The radius of the turn is determined in accordance with the formula $\vec{v} = [\vec{\omega}, \vec{r}]$.

We use SGI's Inventor API for mapping the data from the Theremins to the parameters of the user's viewpoint in the virtual environment and for rendering the scene stored in the Inventor file format.

Our numerous tests with different people show that they immediately recognize the described above relations between the position of the hand and the change of viewpoint's parameters in the virtual environment.

4 Conclusion. Future work

We have tested the described interfaces with a large number of visitors during our public demonstrations. The first - and probably most important - observation was that virtually all people, disregarding of age and sex, who tried the VB and our Theremins' interface, adapted to the system within a minute or less without any adjustment of the system.

Our approach for electrostatic field sensing serves only for the prove of the concept as there would arise a lot of difficulties when using three or more antennas for measurements of additional parameters of the user's hand. Those difficulties come from self interference of Theremins and

more advanced signal processing, as it is impossible to completely separate regions in which the basic frequency of each Theremin is located when the number of used Theremins is large enough.

Nevertheless, our rather simple approach of electrostatic field sensing can be applied for reliable controlling of one or two parameters in the virtual environment. In particular, we plan to use electrostatic field sensors for direct controlling of the speed of the motion on the VB to eliminate its largest disadvantage.

It was not surprising for us that both interfaces were requested by disciplines working on the body and the senses (e.g. neurophysiologists, dancers, game industry). Medical researchers identified the VB and electrostatic field sensors as tools for research for handicapped people, e.g. motion control or problems of body balance.

References

- [1] Brave, S., Ishii, H., Dahley, A., "Tangible Interfaces for Remote Collaboration and Communication", in Proceedings of CSCW '98, Seattle, Washington USA, November, 1998, ACM Press, pp. 169-178.
- [2] Fleischmann, M., "Imagination Systems - Interface Design for Science", Art & Education; Proceedings, IMAGINA'96, Monte Carlo
- [3] Krüger, W. et al, "The Responsive Workbench: A Virtual Work Environment", Virtual Environments, Computer, IEEE, July, 1995
- [4] Fleischmann, M., Bohn, C., Strauss, W., "Rigid Waves - Liquid Views", Visual Proceedings: Machine Culture, Siggraph'93, Anaheim, LA
- [5] Fleischmann, M. et al, "Virtual Balance. An Input Device for VR Environments", Man-Machine Interaction, International Conference, Montpellier, May 28-30, 1997
- [6] Smith, J.R., "Field Mice: Extracting Hand Geometry from Electric Field Measurements", IBM Systems Journal, pp. 587-608, Vol 35, NOS 3&4, 1996
- [7] Paradiso, J., Gershenfeld, "Musical Applications of Electric Field Sensing", Computer Music Journal, Vol. 21, No.2, 1997
- [8] Smith, J. et al, "Electric Field Sensing For Graphical Interfaces", Special Issue on Input Devices, IEEE Computer Graphics and Applications, May 98
- [9] Smythe, W., "Static and Dynamic Electricity", Third Edition, McGraw-Hill Book Company, 1968

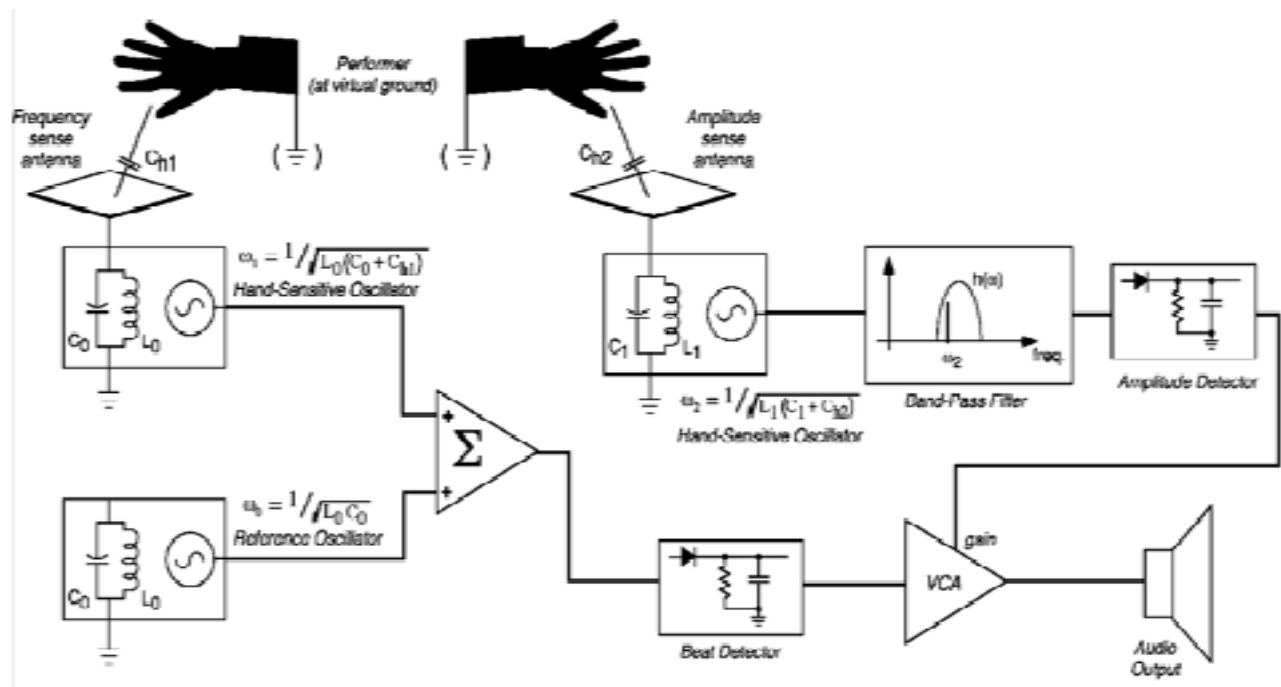

Fig.9. : Design of the classical Theremin (the picture from [7]).

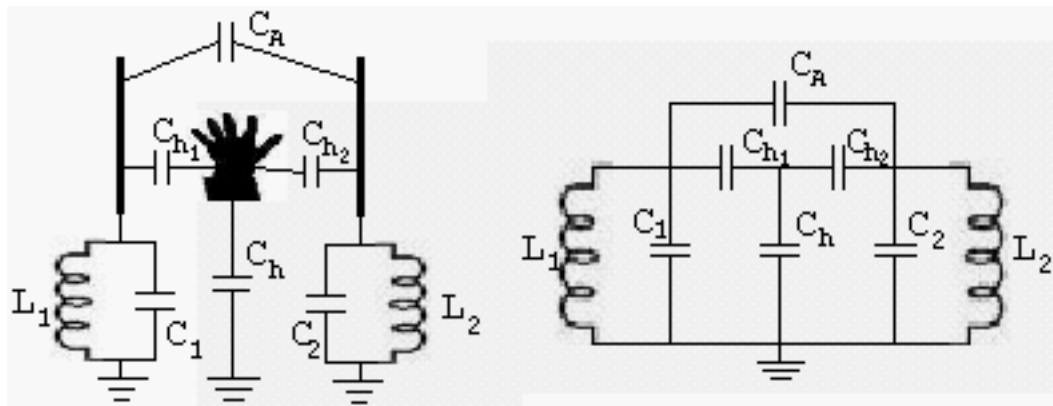

Fig.10. : The equivalent electrical scheme in our application.